



STAS multirail

accessories

buying guide



STAS multirail accessories

Assemble your STAS multirail system step by step. In this brochure we have created an overview of all rail types, light fixtures, spotlights, adapters, hooks and cords.

Step 1: choose a multirail	3
Step 2: choose a spotlight <ul style="list-style-type: none">• Wi-Fi smart LED 5 W / 100°• led spot 3,5 W 27°• led spot 3,5 W 95°	4
Step 3: choose a fixture <ul style="list-style-type: none">• fixture “classic”• fixture “signo”• fixture “sirius”	5
Step 4: choose an adapter	6
Step 5: choose hooks and cords	7
STAS assembly instructions fixtures	8

For assembly instructions of the rail systems: www.stasgroup.com/en/documentation

STEP 1:
choose a multirail

STEP 2:
choose a spotlight

STEP 3:
choose a fixture

STEP 4:
choose an adapter

STEP 5: choose
hooks and cords

STAS multirail systems are picture rails with integrated 12 V power supply wires (low voltage). Thanks to these wires, it is possible to click a light fixture into the rail at any spot to illuminate your wall decor. STAS offers five rail types:

Multirail for walls:

STAS multirail

The classic, patented 12 V rail.

STAS multirail crown

The multirail crown disappears behind your moulding of choice.

STAS multirail max

The multirail max features a top rim that closes the small gap between rail and ceiling.

Multirail for ceilings:

STAS multirail flat

The multirail flat can be installed almost invisibly in plasterwork or behind flat moulding.

STAS u-rail multi

The u-rail multi was specifically designed for drop ceilings.

STEP 1: choose a multirail

STAS multirail

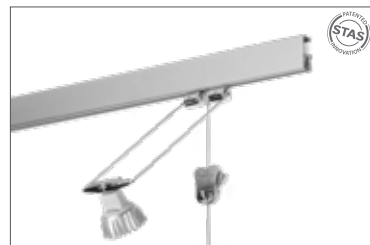

STAS multirail white VH10150 150 cm VH10200 200 cm VH10300 300 cm	STAS multirail alu VH30150 150 cm VH30200 200 cm VH30300 300 cm	STAS multirail black VH20150 150 cm VH20200 200 cm VH20300 300 cm
---	---	---

STAS multirail matching installation accessories

VE10200	STAS multirail endcap white
VE30200	STAS multirail endcap alu
VE20200	STAS multirail endcap black
VD10400	STAS multirail cornercap white
VD30400	STAS multirail cornercap alu
VD20400	STAS multirail cornercap black

RD40100	STAS rail clip (metal, 3 per m ²)
RD40200	STAS rail connector
SR30600	STAS screw torx
SR50700	STAS plug

VF50200	STAS multirail conductor 12 V straight
VF50100	STAS multirail conductor 12 V corner

STAS multirail max



STAS multirail max white VC10420 200 cm VC10430 300 cm	STAS multirail max alu VC30420 200 cm VC30430 300 cm
---	---

STAS multirail max matching installation accessories

VE10400	STAS multirail max endcap white
VE30400	STAS multirail max endcap alu
VD20500	STAS multirail max corner cap white
VD30500	STAS multirail max corner cap alu

RD40100	STAS rail clip (metal, 3 per m ²)
RD40200	STAS rail connector
SR30600	STAS screw torx
SR50700	STAS plug

VF50200	STAS multirail conductor 12 V straight
VF50100	STAS multirail conductor 12 V corner

STAS multirail crown

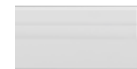
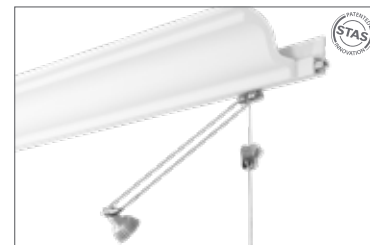

STAS multirail crown white RC10420 200 cm RC10430 300 cm

STAS multirail crown matching installation accessories

RD20400	STAS multirail crown rail connector
RD20500	STAS multirail crown corner connector
SJ10200	STAS multirail crown screw
SR50700	STAS plug

VF50200	STAS multirail conductor 12 V straight
VF50100	STAS multirail conductor 12 V corner

STAS multirail flat



STAS multirail flat white RC10520 200 cm RC10530 300 cm (4 holes per m ²)

STAS multirail flat matching installation accessories

RD20400	STAS multirail flat rail connector
RD20500	STAS multirail flat corner connector
SJ10200	STAS multirail flat screw
SR50700	STAS plug

VF50200	STAS multirail conductor 12 V straight
VF50100	STAS multirail conductor 12 V corner

STAS u-rail multi system



STAS u-rail multi white VP10200 200 cm VP10300 300 cm (8 holes per m ²)	STAS u-rail multi alu VP30200 200 cm VP30300 300 cm (8 holes per m ²)
---	---

STAS u-rail multi black

VP20200	200 cm
VP20300	300 cm

(8 holes per m²)

STAS u-rail multi matching installation accessories

SP10100	STAS u-rail screw white
SP20100	STAS u-rail screw black
SP30100	STAS u-rail screw alu

VF50200	STAS u-rail multi conductor 12 V straight
VF50100	STAS u-rail multi conductor 12 V corner

Beautiful art deserves beautiful lighting.
Which spotlight do you choose?
You can choose between smart LED lighting or our regular LED lighting.

STAS Wi-Fi smart LED

The STAS Wi-Fi smart LED is a smart LED lamp that can be used with the STAS classic fixture. With the accompanying free app and connected to your Wi-Fi network, you can easily switch the STAS Wi-Fi smart LED lamps on and off. It is even possible to illuminate each painting individually with the desired light color and light intensity (2700K warm light > 6500K day light). From fresh light in the morning to warm light in the evening.

STAS led spots

We have 2 different LED spots in our range. Are you going for a narrow beam or a wide beam? Make the right choice based on the type of painting you want to hang.

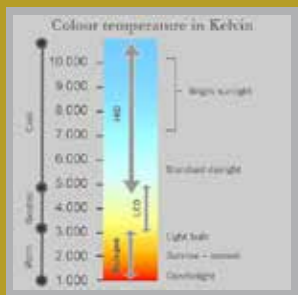

STEP 2: choose a spotlight

E-smart LED spot (dimmable)

STAS Wi-Fi smart LED 5 W / 100°



Can be dimmed and illuminated with different light colors and light intensity by smartphone or remote control.

VL20300W Wi-Fi smart-led white
VL20300Z Wi-Fi smart-led silver

Power	5 W
Output equivalent	30 W
Max. consumption	5 W
Light intensity	300 lm
Infrared radiation	none
Colour temperature cool	6500 K + RGB
Colour temperature warm	2700 K
Light beam	standard - diffuse
Beam angle	100°
Socket	MR16-GU5.3
Vibrational impact	low
Lifespan	15000
Energy class	A+

Standard LED spots

STAS led spot 3,5 W / 27°

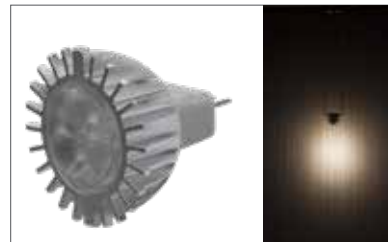

Has a narrow beam suitable for small paintings.

	VL10200
Power	3.5 W
Output equivalent	20 W
Max. consumption	3.5 W
Light intensity	200 lm
Infrared radiation	none
Light colour	warm white
Colour temperature	2700 K
Light beam	standard - diffuse
Beam angle	27°
Socket	MR11-GU4.0
Vibrational impact	low
Lifespan	40.000 hrs
Energy class	A+

STAS led spot 3,5 W / 95°

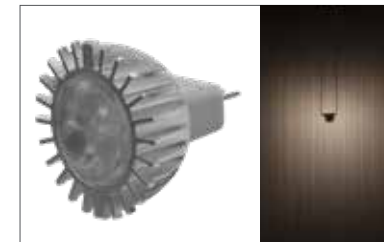

Has a wide beam of light and is therefore suitable for large works of art.

	VL10900
Power	3.5 W
Output equivalent	20 W
Max. consumption	3.5 W
Light intensity	200 lm
Infrared radiation	none
Light colour	warm white
Colour temperature	2700 K
Light beam	standard - diffuse
Beam angle	95°
Socket	MR11-GU4.0
Vibrational impact	low
Lifespan	40.000 hrs
Energy class	A+

STEP 3: choose a fixture

STAS fixtures can be clicked easily into your STAS multirail. All spots are compatible with all fixtures, and all fixtures are compatible with all STAS multirail systems.

How to choose

- The bigger the distance between light source and wall, the bigger the artwork that can be illuminated. In other words: choose a large fixture for lighting a large work of art.
- Is your wall 270 cm high or higher? We would recommend installing a fixture of 70 cm.

Adjusting

The classic fixtures can be adjusted by loosening and tightening the screws on the side of the lamp. All other fixtures have a flexible part that allows you to make small adjustments in the direction of the light beam.

Warranty

1 year warranty applies to all fixtures.

STAS classic fixture



Length: 50 cm and 70 cm
Colour: white and chrome

STAS multirail classic fixtures

- | | |
|---------|---|
| VA10500 | STAS multirail fixture classic white 50 cm |
| VA10700 | STAS multirail fixture classic white 70 cm |
| VA30500 | STAS multirail fixture classic chrome 50 cm |
| VA30700 | STAS multirail fixture classic chrome 70 cm |

STAS sirius fixture



Length: 40, 50 en 65 cm
Colour: chrome

STAS multirail sirius fixtures

- | | |
|---------|--|
| VA30365 | STAS multirail fixture sirius chrome 40 cm |
| VA30465 | STAS multirail fixture sirius chrome 50 cm |
| VA30665 | STAS multirail fixture sirius chrome 65 cm |

STAS signo fixture



Length: 70 cm
Colour: chrome

STAS multirail signo fixtures

- | | |
|---------|---|
| VA30770 | STAS multirail fixture signo chrome 70 cm |
|---------|---|

Classic fixture 50 cm

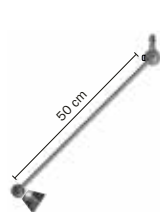

Classic fixture 70 cm



VA30770 signo 70 cm



VA30365 sirius 40 cm



VA30465 sirius 50 cm



VA30665 sirius 65 cm



STAS offers 3 different adapters. The choice of an adapter depends on 3 things:

1. the type of spotlight you'd like to use
2. the number of spotlights you'd like to install
3. the number of meters of rail you'd like to install

Using multiple adapters

In case you would like to use more than the above mentioned number of meters or spots, you will have to use multiple adapters.

CAUTION:

Create independent circuits when using more than one adapter! Adapters must never be connected, neither directly nor indirectly. In short: NEVER connect two rail segments that are each connected to a different adapter! Exclusively connect rail segments that share one adapter.

Dimming of light

The lighting can only be dimmed using the STAS Wi-Fi smart LED in combination with the corresponding classic fixture. The rest of the LED lamps are not dimmable. We strongly advise against connecting a switch or dimmer to a system yourself. Be aware that if you do this anyway, all system warranty expires.

STEP 4: choose an adapter

Adapter 18 W



Adapter 36 W



Adapter 84 W



Number of spotlights

		Led 3,5 W	Led 5 W
VT20500	Adapter 18 W	4	2
VT20036	Adapter 36 W	8	6
VT20084	Adapter 84 W	20	14
Maximum number of meters of rail per adapter		16	16

Product information

STAS adapters			
	VT20500 STAS multirail adapter 18W	VT20036 STAS multirail adapter 36W	VT20084 STAS multirail adapter 84W
Input voltage	AC100-240 V ~ 50/60 Hz 0.7 A	100-240VAC 50/60Hz	100-240VAC 50/60Hz
Output voltage	DC 12 V == 1.5 A	12V DC 3A	12V DC 7A
Ampère	1.5 A	3A	7A
Dimensions (l x h x w)	75 x 86 x 36 mm	105 x 45 x 28.5 mm	155 x 60 x 37mm
Weight	180 gr	220 gr	490 gr
Connection	input plug (EU) output cable 3 m	input plug (EU) (US) 1.8 m output cable 3 m	input plug (EU) (US) 1.8 m output cable 3 m
Quality label	CE GS TÜV WEEE	UL CE EMC RoHS REACH	UL CE EMC RoHS REACH

STAP 5: choose hooks and cords

**STAS smartspring on
STAS cobra + perlon cord**



**STAS zipper on
STAS cobra + perlon cord**



**STAS zipper on
STAS cobra + steel cable**

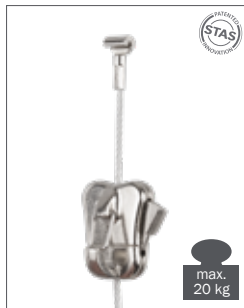

**STAS zipper on STAS cobra +
steel cable (black or white)**



STAS zipper pro



NB: The STAS zipper pro can be applied in the same way as the STAS zipper.

Hanging your art is the very last step. To do that, you will need hooks and cords.

Consider two factors when choosing your hooks and cords:

1. the weight of the object you wish to hang
2. the look that appeals most to you

Choose one of four possible combinations.

For assembly instructions of the rail systems:
www.stasgroup.com/en/documentation



: www.stasgroup.com + YouTube

STAS assembly instructions pictures

STAS classic fixture

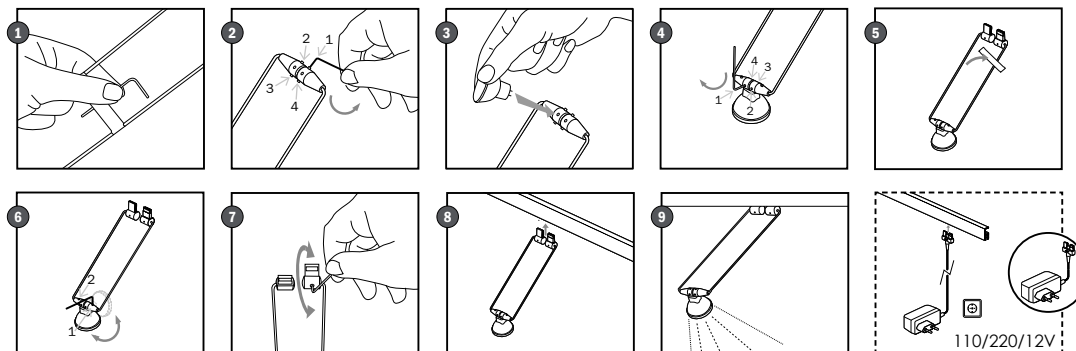

STAS signo + sirius fixture

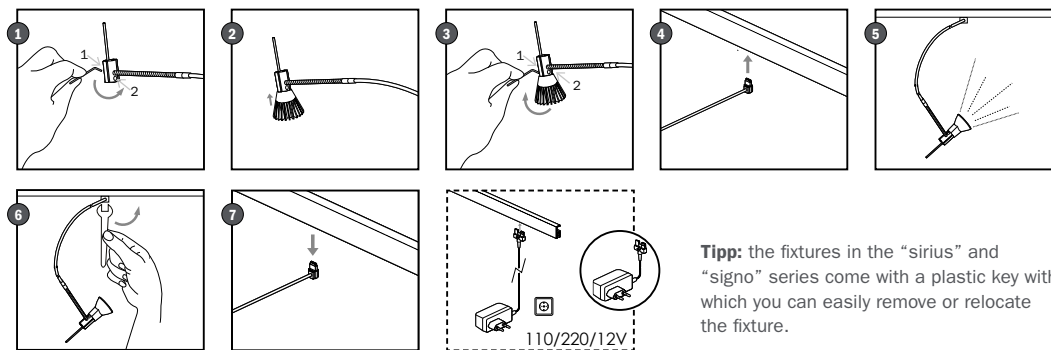

Tipp: the fixtures in the “sirius” and “signo” series come with a plastic key with which you can easily remove or relocate the fixture.